

ENERGY 70

HDF-levypintainen ulko-ovi

Ulosaukeava, yksilehtinen Energy 70 on suosituin ulko-ovemme, joka sopii kohteeseen kuin kohteeseen. E70 on esimerkiksi erinomainen valinta saneerauskohteen ulko-oven ovirakenteeksi.

RAKENNE JA HELAT

- Karmi sormijatkettua mäntyä, näkyvät pinnat oksattomat
- Ovilehden paksuus 70 mm, ulkopuoli uritettu ja sisäpuoli sileä
- Lasiukollinen tai umpiovi
- Pintalevyt: HDF ja alumiinijäykiste
- Platina-eriste
- Runko mäntyä ja kertopuujäykiste
- Kaksinkertainen vakiotiivistys, tiiviste myös kynnyksessä
- Karmisyvyys 115, 130, 150, 170 tai 210 mm
- Kynnys kovapuuta alumiinisella kulutuslistalla
- Lukkorunko Abloy LC102, säädettävä vastarauta, murtosuojatut sekä korkeussäädettävät saranat 4 kpl
- Muut pintahelat ovat lisävarusteita

LASITUS

- Ovilehdessä 3K-selektiivilasielementti argonkaasutäytteellä
- SuperSpacer-väliä, värit: vaaleanharmaa tai musta

PINTAKÄSITTELY

- Peittomaalaus
- Vakiosävy rakennuspuunvalkoinen NCS S 0502-Y
- Mahdollisuus 2-värimaalaukseen
- Pintakäsittelyaineet kuuluvat rakennusmateriaalien päästöluokitusten M1-ryhmään

KOKORAJOITUKSET

- Maksimikoko yksittäisellä ovella 1190*2490 mm
- Minimikoko yksittäisellä ovella 590*590 mm
- Maksimikoko pariovella 2390*2490 mm
- Minimikoko pariovella 1190*590 mm

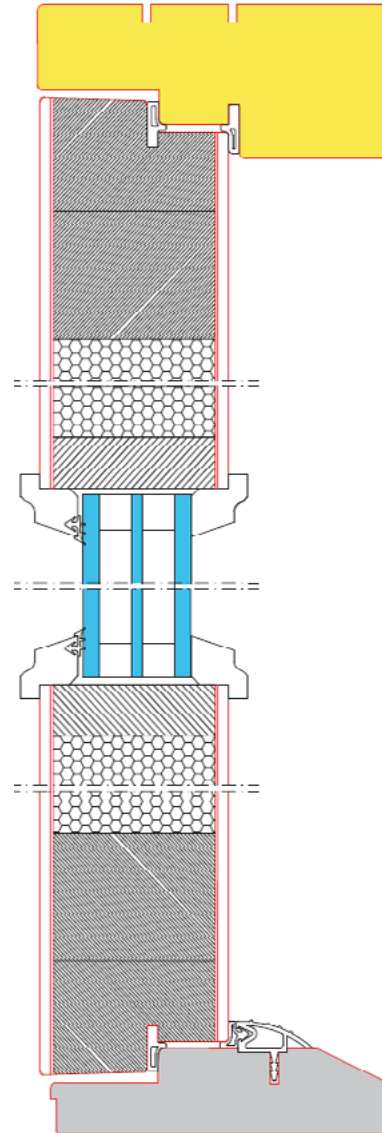

LISÄVARUSTEET

- Painike ja avainpesä
- Turvalukkorunko ja -avainpesä
- Erikoislasisitus
- Erikoisväri
- Kirjeluukku
- Lautasventtiili
- Murtosuojarauta
- Ovikello
- Ovipumppu
- Ovisilmä
- Potkupelti
- Sähkötoimisille heloituksille koneistukset ja sähköputkitukset

TEKNISET TIEDOT ENERGY 70 ULKO-OVI

130 mm karmisyvyydellä

Ovimalli	Lasitus	Rw (dB)	Rw+C (dB)	Rw+Ctr (dB)	U-arvo (W/m ² K)
Umpiovi	-	26	24	24	0,69
Lasiaukolla	3K_4S1N/4/S1N4-16/14SS	29	27	26	0,77
Usealla lasiaukolla	3K_4S1N/4/S1N4-16/14SS	29	27	26	0,89
Isolla lasiaukolla	3K_6S1N/4/S1N6-14/12SS	29	27	26	0,91
Kokolasisena	3K_6S1N/4/S1N6-14/12SS	29	27	26	0,94

Rw = ilmäääneneristävyys

Rw + C = lentomelu

Rw + Ctr = liikennemelu

U-arvo = oven lämmönläpäisykerroin (W/m²K)

E70-OVIRAKENTEELLA SAATAVAT OVIMALLIT

Umpiovet

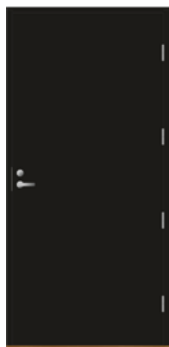

Ei uritusta



Vehka



Pennala



Ritola



Hemminki

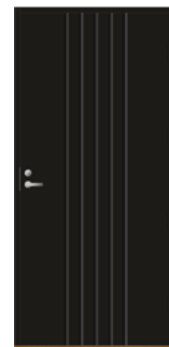

Niinimaa



Lapinkylä



Matara



Kätkä



Kasarmi

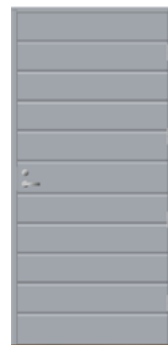

Hukkala

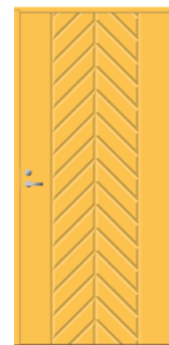

Seinäjärvi

E70-OVIRAKENTEELLA SAATAVAT OVIMALLIT

Ulko-ovet pienellä lasiaukolla



Kontola



Vetis



Suutala



Sapsu



Soukka



Soukka vaaka



Röyskö



Ritari



Riikku



Linna

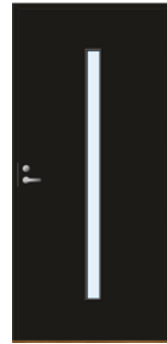

Kitula

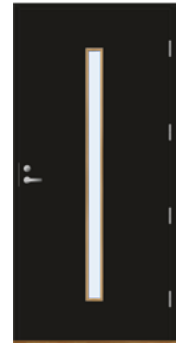

Kitula tammilista



Seppä

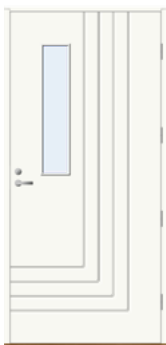

Rajala



Rajala vaaka



Jääskä



Hakojärvi

Ulko-ovet usealla lasiaukolla

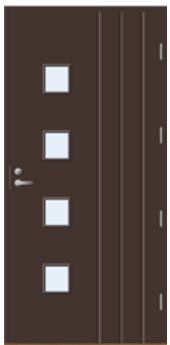

Härkölä

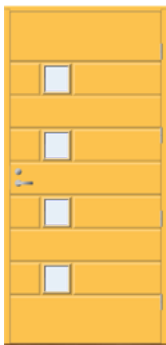

Härkölä
vaaka



Jokivarsi



Kaarti

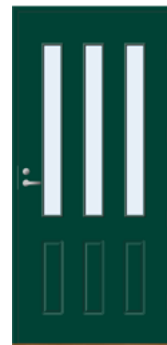

Kätkä 3



Kattelus

E70-OVIRAKENTEELLA SAATAVAT OVIMALLIT

Ulko-ovet usealla lasiaukolla



Kolisto 3



Kolisto 3
tammilista



Kolisto 4

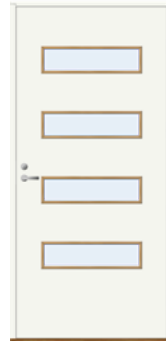

Kolisto 4
tammilista



Kolisto



Kolisto
tammilista



Konttinen

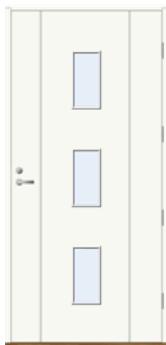

Kumola



Penttilä



Rajala 2



Rajala 2 vaaka



Sydänmaa



Taipalus 3



Taipalus 4

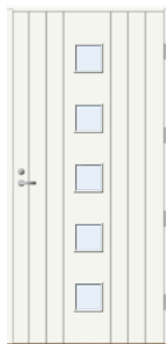

Taipalus



Tohni



Ylipää

Ulko-ovet suurella lasiaukolla



IOU pysty

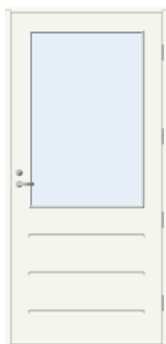

IOU vaaka



IOU vaaka 2



IOU
kokolasinen



Lahdenkylä



Töysä

E70-OVIRAKENTEELLA SAATAVAT OVIMALLIT

Ulko-ovet suurella lasiaukolla



Tusa



Riikku 2



Lepola



Itäranta

Avattavat ja kiinteät levikkeet



A1, K1



A2, K2



A3, K3



A4, K4



A5, K5



A6, K6



A7, K7



A8, K8